

HumiTherm Ultra

Temperature + Humidity (%RH) Control & Recording System with 8 / 16 Mapping Inputs

Operation Manual

This brief manual is primarily meant for quick reference to wiring connections and parameter searching. For more details on operation and application; please log on to www.ppiindia.net



101, Diamond Industrial Estate, Navghar, Vasai Road (E), Dist. Palghar - 401 210.
T: 0250 - 2391722/33/37/42 M: 07498799226 / 09321985369
E: sales@ppiindia.net, support@ppiindia.net

Level	Sub-Level	Parameters	Range (Default)																		
Operator		Temperature Set Value	Temp. Setpoint Low Limit to Temp. Setpoint High Limit (Default : 25.0 °C)																		
		Temperature Low Deviation Alarm	0.2 to 99.9 °C (Default : 2.0 °C)																		
		Temperature High Deviation Alarm	0.2 to 99.9 °C (Default : 2.0 °C)																		
		%RH Set Value	%RH Setpoint Low Limit to Temp. Setpoint High Limit (Default : 60.0 %)																		
		%RH Low Deviation Alarm	0.2 to 99.9 % (Default : 2.0 %)																		
		%RH High Deviation Alarm	0.2 to 99.9 % (Default : 2.0 %)																		
		SP Edit on Home Screen	Enable / Disable																		
Supervisory	Recording	Recording Interval	1 to 250 Minutes (Default : 5 Minutes)																		
		'Delete Record' Command	NA																		
	Clock & Calendar	Calendar Date (DD/MM/YY)	NA																		
		Clock Time (HH:MM:SS)	NA																		
	SMS Alert	GSM Machine ID	1 to 128 (Default : 1)																		
		Reset GSM Module	NA																		
Door Lock Access	Lock Position (On / Off)	Solenoid ON / Solenoid OFF (Default : Solenoid OFF)																			
	Password Entry	NA																			
Standby Switching	'Switch Main/Standby Outputs'	NA																			
	'Switch to Standby Sensors'	NA																			
Maintenance	Repair Acknowledge 'Control Gadget' 'Input Sensor'	NA																			
Factory	Input Settings	Input Type	*RTD Pt100, 0 to 20mA, 4 to 20mA, 0 to 5V, 0 to 10V, 1 to 5V (Default : For Temp. Input : RTD Pt100 For %RH Input : 0 to 5V) *Available for Temp. Input Only																		
		Signal Range Low	<table border="1"> <thead> <tr> <th>Input Type</th> <th>Settings</th> <th>Default</th> </tr> </thead> <tbody> <tr> <td>0 to 20mA</td> <td>0.00 to Signal High</td> <td>0.00</td> </tr> <tr> <td>4 to 20mA</td> <td>4.00 to Signal High</td> <td>4.00</td> </tr> <tr> <td>0 to 5V</td> <td>0.000 to Signal High</td> <td>0.000</td> </tr> <tr> <td>0 to 10V</td> <td>0.00 to Signal High</td> <td>0.00</td> </tr> <tr> <td>1 to 5V</td> <td>1.000 to Signal High</td> <td>1.000</td> </tr> </tbody> </table>	Input Type	Settings	Default	0 to 20mA	0.00 to Signal High	0.00	4 to 20mA	4.00 to Signal High	4.00	0 to 5V	0.000 to Signal High	0.000	0 to 10V	0.00 to Signal High	0.00	1 to 5V	1.000 to Signal High	1.000
	Input Type	Settings	Default																		
	0 to 20mA	0.00 to Signal High	0.00																		
	4 to 20mA	4.00 to Signal High	4.00																		
	0 to 5V	0.000 to Signal High	0.000																		
	0 to 10V	0.00 to Signal High	0.00																		
	1 to 5V	1.000 to Signal High	1.000																		
	Input Settings	Signal Range High	<table border="1"> <thead> <tr> <th>Input Type</th> <th>Settings</th> <th>Default</th> </tr> </thead> <tbody> <tr> <td>0 to 20mA</td> <td>Signal Low to 20.00</td> <td>20.00</td> </tr> <tr> <td>4 to 20mA</td> <td>Signal Low to 20.00</td> <td>20.00</td> </tr> <tr> <td>0 to 5V</td> <td>Signal Low to 5.000</td> <td>5.000</td> </tr> <tr> <td>0 to 10V</td> <td>Signal Low to 10.00</td> <td>10.00</td> </tr> <tr> <td>1 to 5V</td> <td>Signal Low to 5.000</td> <td>5.000</td> </tr> </tbody> </table>	Input Type	Settings	Default	0 to 20mA	Signal Low to 20.00	20.00	4 to 20mA	Signal Low to 20.00	20.00	0 to 5V	Signal Low to 5.000	5.000	0 to 10V	Signal Low to 10.00	10.00	1 to 5V	Signal Low to 5.000	5.000
		Input Type	Settings	Default																	
		0 to 20mA	Signal Low to 20.00	20.00																	
		4 to 20mA	Signal Low to 20.00	20.00																	
0 to 5V		Signal Low to 5.000	5.000																		
0 to 10V		Signal Low to 10.00	10.00																		
1 to 5V	Signal Low to 5.000	5.000																			
Display Range Low	-199.9 to Range High (Default : 0.0)																				
Display Range High	Range Low to 999.9 (Default : 100.0)																				
Zero Offset	-50.0 to 50.0 (Default : 0.0)																				
Alarm Settings	Inhibit	Enable, Disable (Default : Enable)																			
	Low Alarm Deviation / High Alarm Deviation	0.2 to 99.9 (Default : 2.0)																			
	Hysteresis	0.1 to 99.9 (Default : 0.2)																			

Level	Sub-Level	Parameters	Range (Default)
Factory	Control Settings	Dual Zone	
		Heat Zone PID Constants	0.1 to 999.9 °C (Default : 50.0 °C)
		Heat Zone Proportional Band	0 to 3600 Sec. (Default : 100 Sec.)
		Heat Zone Integral Time	0 to 600 Sec. (Default : 16 Sec.)
		Heat Zone Derivative Time	0.1 to 999.9 °C (Default : 50.0 °C)
		Cool Zone PID Constants	0.1 to 999.9 °C (Default : 50.0 °C)
		Cool Zone Proportional Band	0 to 3600 Sec. (Default : 100 Sec.)
		Cool Zone Integral Time	0 to 600 Sec. (Default : 16 Sec.)
		Cool Zone Derivative Time	0.1 to 999.9 °C (Default : 50.0 °C)
		Single Zone	
	Proportional Band	0 to 3600 Sec. (Default : 100 Sec.)	
	Integral Time	0 to 600 Sec. (Default : 16 Sec.)	
	Derivative Time	0.1 to 999.9 °C (Default : 50.0 °C)	
	Single Zone & Dual Zone		
	Output Cycle Time (Sec.)	0.5 to 100.0 Sec. (Default : 10.0 Sec.)	
	Set Value (Temperature Control Loop)	Temp. Setpoint Low Limit to Temp. Setpoint High Limit (Default : 25.0)	
	Low Limit (for Temp. Control Set Value)	-199.9 to Temperature Setpoint High Limit (Default : 10.0)	
	High Limit (for Temp. Control Set Value)	For RTD : Temperature Setpoint Low Limit to 600.0 For mA/V : Temperature Setpoint Low Limit to 999.9 (Default : 60.0)	
	Self Tune	NA	
	Compressor		Mode
Compressor SP			0.0 to 100.0 (Default : 45.0)
Boundary SP			0.0 to 100.0 (Default : 45.0)
Time Delay			0 to 1000 Sec. (Default : 200 Sec.)
Hysteresis			0.1 to 99.9 °C (Default : 2.0 °C)
Zone Select			Single, Dual (Default : Single)
Float Detection Enable			Yes / No (Default : No)
Float Low Level Logic			Switch Open, Switch Close (Default : Switch Close)
Thermostat Detection Enable			Yes / No (Default : No)
Thermostat Low Level Logic			Switch Open, Switch Close (Default : Switch Close)
Water Level		Common Boiler	No / Yes (Default : No)
		Detection Enable	No / Yes (Default : No)
		Door Open Logic	Switch Open, Switch Close (Default : Switch Close)
		Alarm Delay (Sec.)	0 to 1000 Sec. (Default : 60 Sec.)
Door Open		Detection Enable	No / Yes (Default : No)
		Power Fail Logic	Switch Open, Switch Close (Default : Switch Close)

Level	Sub-Level	Parameters	Range (Default)																											
Factory	Sensor Inputs	Temperature Low Limit for Sensor Fail Detection	0 to 25.0 °C (Default : 0 °C)																											
		%RH Low Limit for Sensor Fail Detection	0 to 60.0 % (Default : 0 %)																											
	Control Gadgets	Fail Detect Time (Min)	0 to 250 Min. (Default : 10 Min.)																											
		Cyclic Time (Hrs.)	0 to 500 Hrs. (Default : 48 Hrs.)																											
		Inhibit Time (Hrs.)	0 to 250 Hrs. (Default : 1 Hrs.)																											
		Select Mapping Inputs	4T + 4RH, 8T + 8RH (Default : 4T + 4RH)																											
	Configuration	Alarm Settings	Low Alarm Set Value	-199.9 to 600.0 °C (Default : 0 °C)																										
			Low Alarm Hysteresis	0.1 to 50.0 °C (Default : 2.0 °C)																										
			Low Alarm Inhibit	Enable, Disable (Default : Disable)																										
			High Alarm Set Value	-199.9 to 600.0 °C (Default : 0 °C)																										
			High Alarm Hysteresis	0.1 to 50.0 °C (Default : 2.0 °C)																										
			Low Alarm Inhibit	Enable, Disable (Default : Disable)																										
Input Settings		Input Type	*RTD Pt100, 0 to 20 mA, 4 to 20 mA, 0 to 50 mV, 0 to 200 mV, 0 to 1.25 V, 0 to 5 V, 1 to 5 V, 0 to 10 V (Default : For Temp. Input : RTD Pt100 For %RH Input : 0 to 5V) *Available for Temp. Input Only																											
		Signal Range Low	<table border="1"> <thead> <tr> <th>Input Type</th> <th>Settings</th> <th>Default</th> </tr> </thead> <tbody> <tr> <td>0 to 20mA</td> <td>0.00 to Signal High</td> <td>0.00</td> </tr> <tr> <td>4 to 20mA</td> <td>4.00 to Signal High</td> <td>4.00</td> </tr> <tr> <td>0 to 50mV</td> <td>0.00 to Signal High</td> <td>0.00</td> </tr> <tr> <td>0 to 200mV</td> <td>0.0 to Signal High</td> <td>0.0</td> </tr> <tr> <td>0 to 1.25V</td> <td>0.000 to Signal High</td> <td>0.000</td> </tr> <tr> <td>0 to 5V</td> <td>0.000 to Signal High</td> <td>0.000</td> </tr> <tr> <td>1 to 5V</td> <td>1.000 to Signal High</td> <td>1.000</td> </tr> <tr> <td>0 to 10V</td> <td>0.00 to Signal High</td> <td>0.00</td> </tr> </tbody> </table>	Input Type	Settings	Default	0 to 20mA	0.00 to Signal High	0.00	4 to 20mA	4.00 to Signal High	4.00	0 to 50mV	0.00 to Signal High	0.00	0 to 200mV	0.0 to Signal High	0.0	0 to 1.25V	0.000 to Signal High	0.000	0 to 5V	0.000 to Signal High	0.000	1 to 5V	1.000 to Signal High	1.000	0 to 10V	0.00 to Signal High	0.00
		Input Type	Settings	Default																										
		0 to 20mA	0.00 to Signal High	0.00																										
4 to 20mA	4.00 to Signal High	4.00																												
0 to 50mV	0.00 to Signal High	0.00																												
0 to 200mV	0.0 to Signal High	0.0																												
0 to 1.25V	0.000 to Signal High	0.000																												
0 to 5V	0.000 to Signal High	0.000																												
1 to 5V	1.000 to Signal High	1.000																												
0 to 10V	0.00 to Signal High	0.00																												
Signal Range High	<table border="1"> <thead> <tr> <th>Input Type</th> <th>Settings</th> <th>Default</th> </tr> </thead> <tbody> <tr> <td>0 to 20mA</td> <td>Signal Low to 20.00</td> <td>20.00</td> </tr> <tr> <td>4 to 20mA</td> <td>Signal Low to 20.00</td> <td>20.00</td> </tr> <tr> <td>0 to 50mV</td> <td>Signal Low to 50.00</td> <td>50.00</td> </tr> <tr> <td>0 to 200mV</td> <td>Signal Low to 200.0</td> <td>200.0</td> </tr> <tr> <td>0 to 1.25V</td> <td>Signal Low to 1.250</td> <td>1.250</td> </tr> <tr> <td>0 to 5V</td> <td>Signal Low to 5.000</td> <td>5.000</td> </tr> <tr> <td>1 to 5V</td> <td>Signal Low to 5.000</td> <td>5.000</td> </tr> <tr> <td>0 to 10V</td> <td>Signal Low to 10.00</td> <td>10.00</td> </tr> </tbody> </table>	Input Type	Settings	Default	0 to 20mA	Signal Low to 20.00	20.00	4 to 20mA	Signal Low to 20.00	20.00	0 to 50mV	Signal Low to 50.00	50.00	0 to 200mV	Signal Low to 200.0	200.0	0 to 1.25V	Signal Low to 1.250	1.250	0 to 5V	Signal Low to 5.000	5.000	1 to 5V	Signal Low to 5.000	5.000	0 to 10V	Signal Low to 10.00	10.00		
Input Type	Settings	Default																												
0 to 20mA	Signal Low to 20.00	20.00																												
4 to 20mA	Signal Low to 20.00	20.00																												
0 to 50mV	Signal Low to 50.00	50.00																												
0 to 200mV	Signal Low to 200.0	200.0																												
0 to 1.25V	Signal Low to 1.250	1.250																												
0 to 5V	Signal Low to 5.000	5.000																												
1 to 5V	Signal Low to 5.000	5.000																												
0 to 10V	Signal Low to 10.00	10.00																												
Display Range Low	-199.9 to Range High (Default : 0.0)																													
Display Range High	Range Low to 999.9 (Default : 100.0)																													
Zero Offset	-50.0 to 50.0 (Default : 0.0)																													

Note
The Setting and Default Values are the same for Temperature and Humidity (%RH) parameters. The units for Temperature is °C & that for Humidity is %.

ELECTRICAL CONNECTIONS

4.3" HMI Electrical Connections

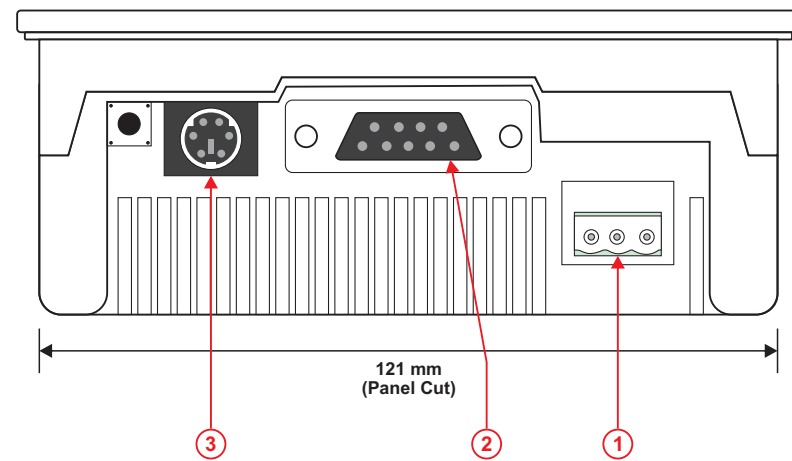

7" HMI Electrical Connections

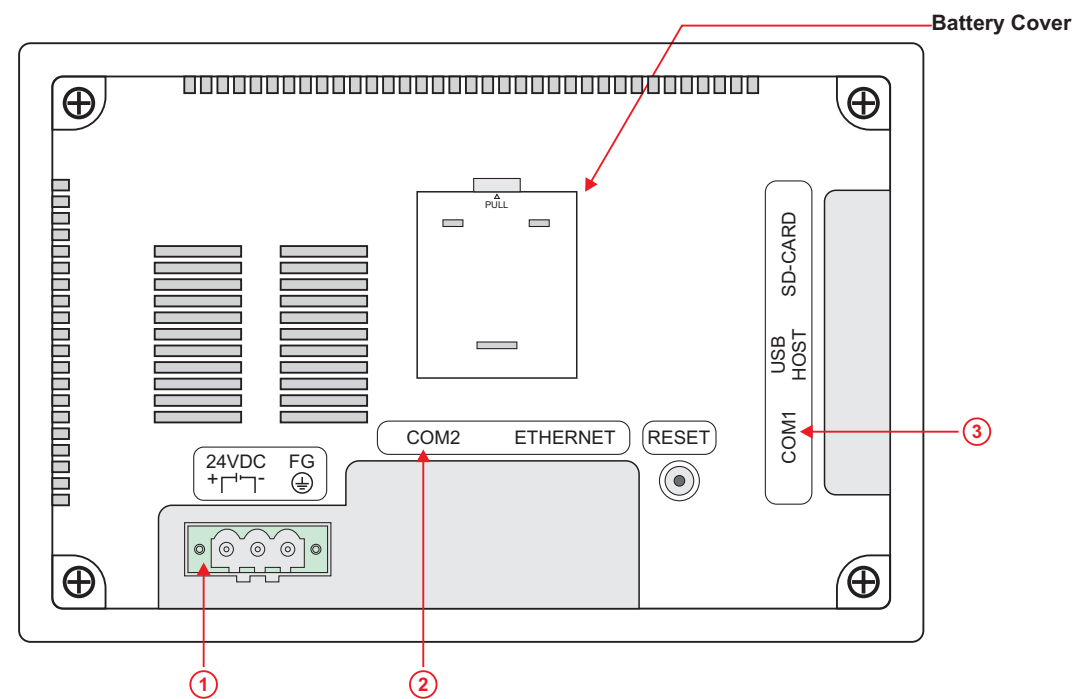

①		3-Pin Male / Female Connector (5.08 mm pitch) Supply Voltage : 20 to 28 VDC (24 V Nominal)
②		9 (4.3" HMI) / 15 (7" HMI) Pin D Type Connector RS485 Serial Communication with microPLC & Mapping Unit
③		6 Pin PS/2 Connector RS232 Serial Communication with PC

microPLC Electrical Connections

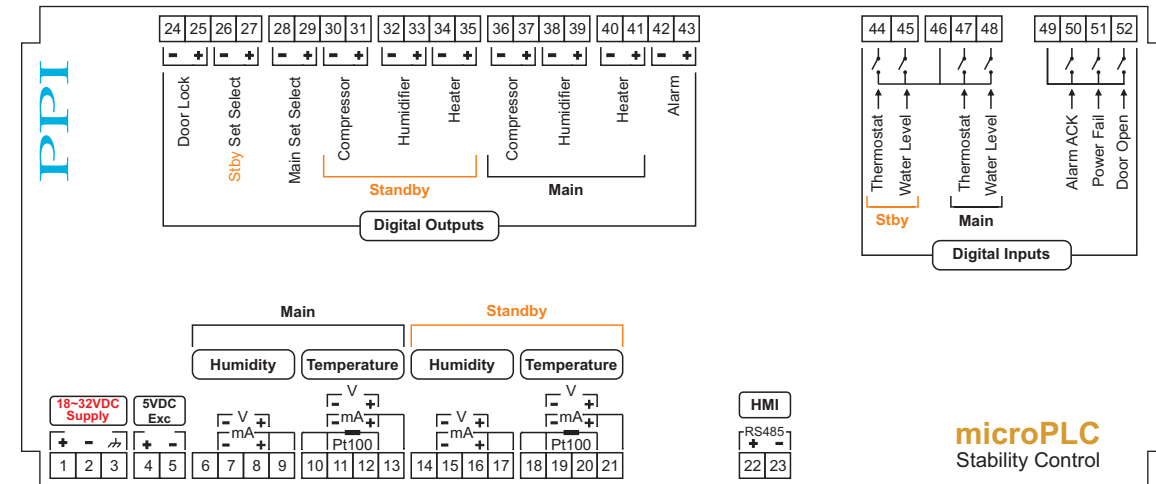

Mapping Module Electrical Connections

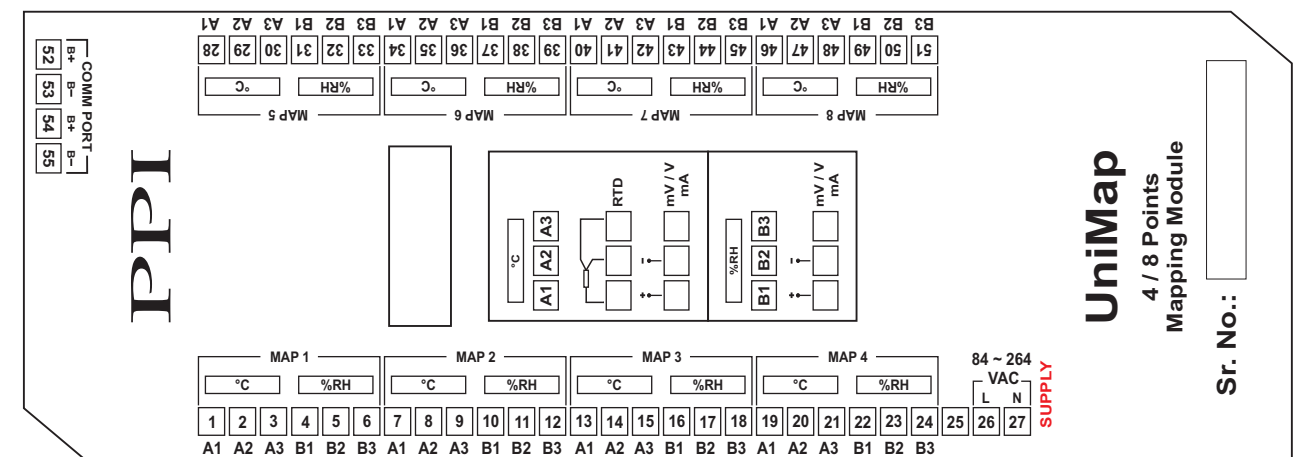

Input Type Jumper Settings For Mapping Module

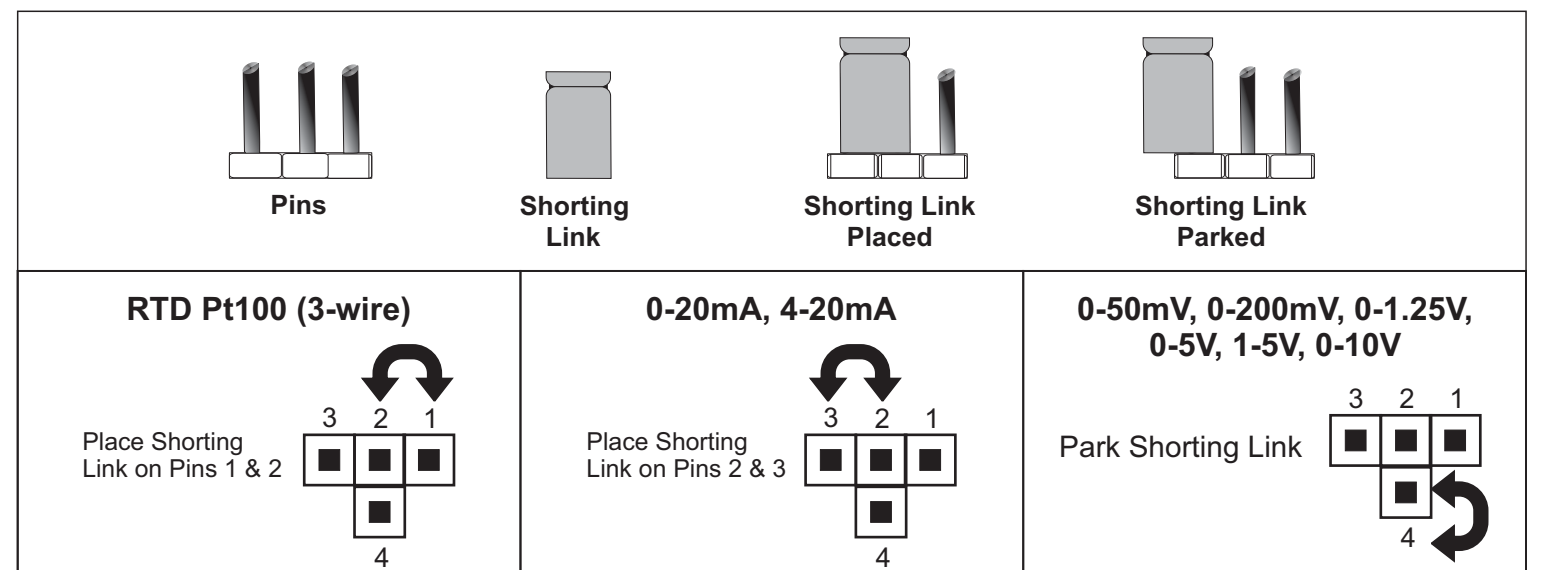

MECHANICAL MOUNTING

4.3" HMI Mounting

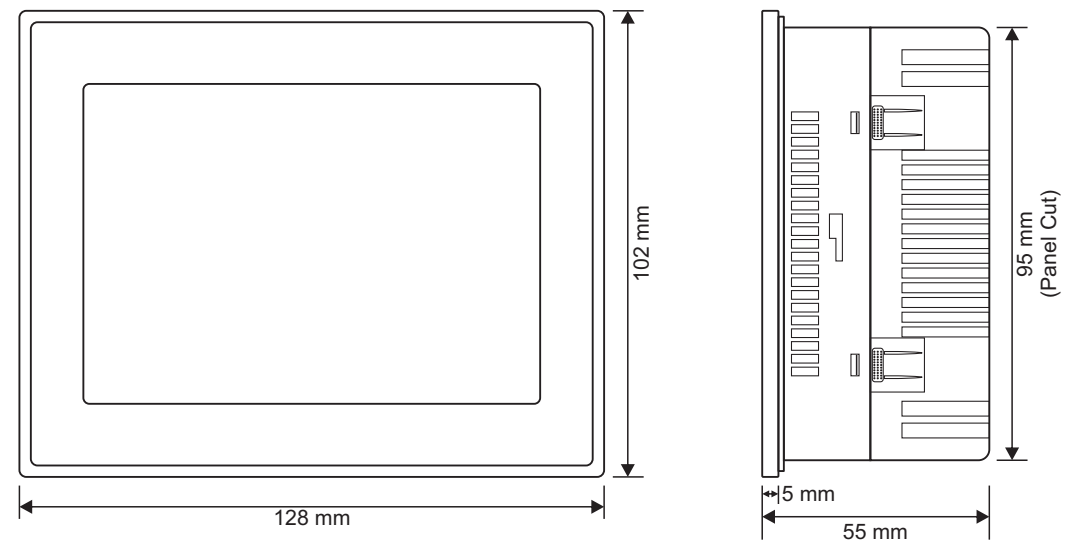

Dimensions	
Overall	128(W) X 102(H) X 55(D), mm
Panel Cutout	121(W) X 95(H), mm

microPLC Mounting

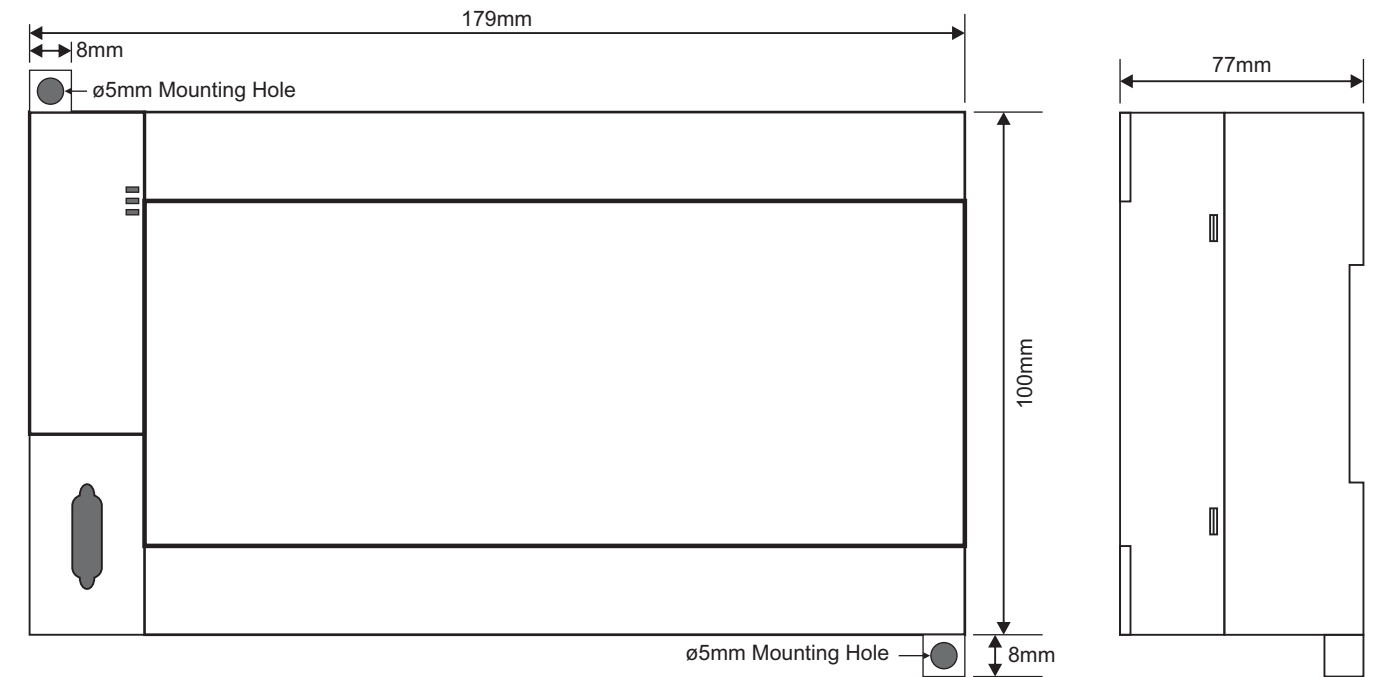

7" HMI Mounting

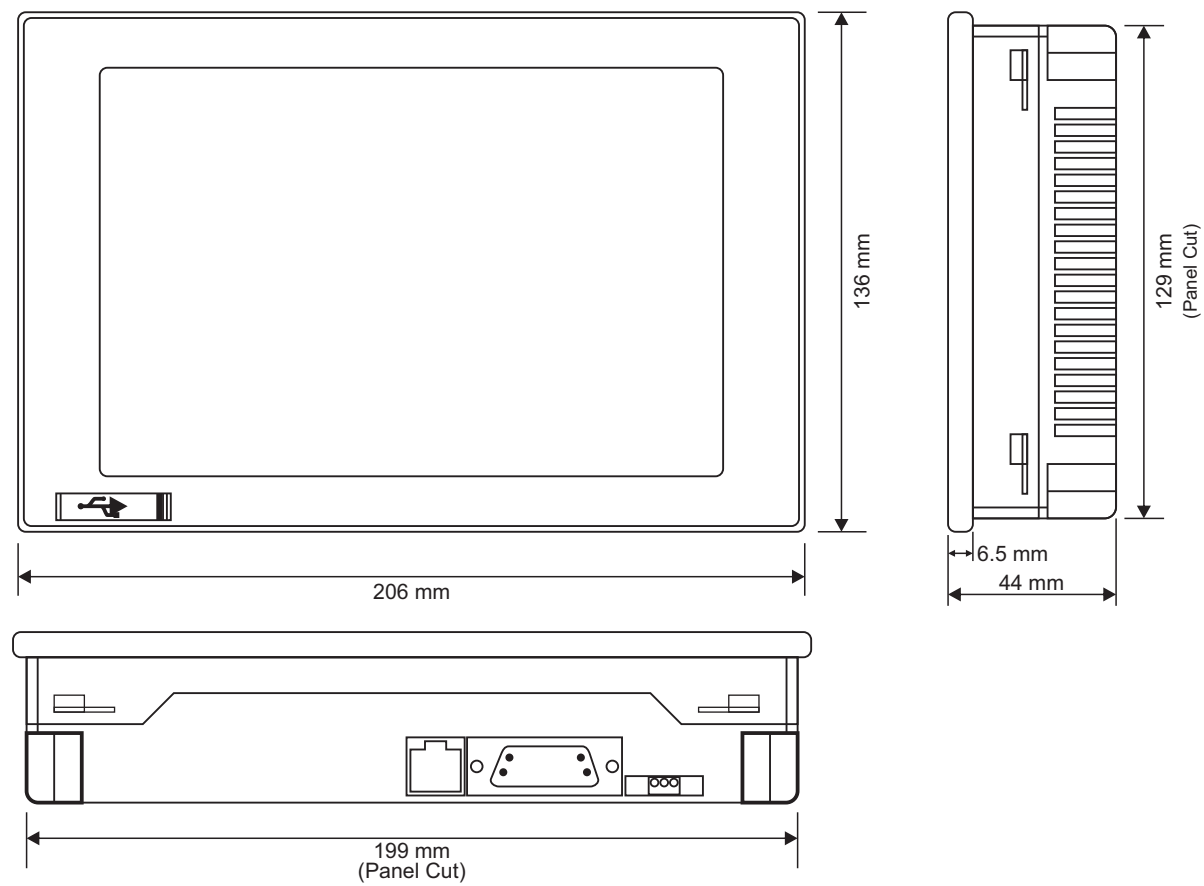

Dimensions	
Overall	206(W) X 136(H) X 44(D), mm
Panel Cutout	199(W) X 129(H), mm

UniMap (4T + 4RH or 8T + 8RH) Mounting

